



Meaningful Innovation.

WEEE Number: 80133970

INSTRUCTION MANUAL

LED BACKLIT PANEL

TECHNICAL DATA

MODEL	VT-61042CCT
SKU	24324
SHAPE	Square
WATTS	40W
LUMEN @SPHERE360°	4800 Lm
BEAM ANGLE	110°
CRI	≥80
DF	≥0.9
BODY TYPE	Fe + PS
ON/OFF CYCLE	20,000 Times
LIFE SPAN	30,000 Hours
OPERATION TEMPERATURE	-10°C to +35°C
PROTECTION RATING	IP20
INPUT VOLTAGE	AC: 220-240V, 50/60Hz
CONNECT WITH DRIVER	1050mA
DIMENSION	595x595x33mm

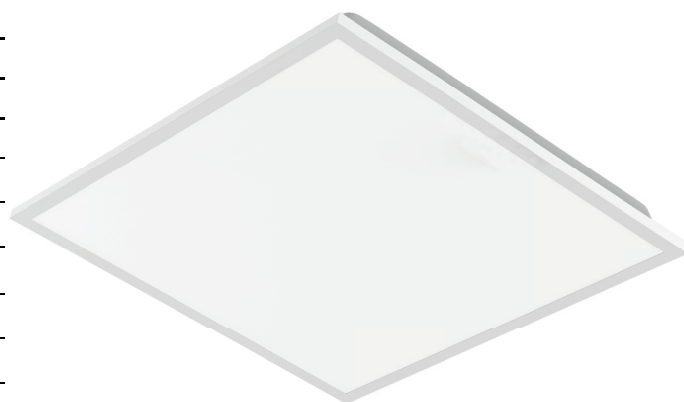

INTRODUCTION & WARRANTY

Thank you for selecting and buying V-TAC product. V-TAC will serve you the best. Please read these instructions carefully before starting the installation and keep this manual handy for future reference. If you have any another query, please contact our dealer or local vendor from whom you have purchased the product. They are trained and ready to serve you at the best. The warranty is valid for 5 years from the date of purchase. The warranty does not apply to damage caused by incorrect installation or abnormal wear and tear. The company gives no warranty against damage to any surface due to incorrect removal and installation of the product. The products are suitable for 10-12 Hours Daily operation. Usage of product for 24 Hours a day would void the warranty. This product is warranted for manufacturing defects only.

WARNING

1. Please make sure to turn off the power before starting the installation.
2. Installation should only be done by a certified electrician.
3. The light source of this luminaire is not replaceable; when the light source reaches its end of life the whole luminaire shall be replaced.
4. If the external flexible cable or cord of this luminaire is damaged, it shall be exclusively replaced by the manufacturer or his service agent or a similar qualified person in order to avoid a hazard.
5. For Indoor use only



This marking indicates that this product should not be disposed of with other household wastes.

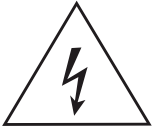

Caution, risk of electric shock.

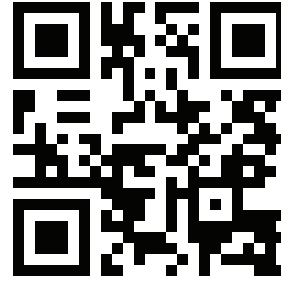

MULTI-LANGUAGE MANUAL QR CODE

Please scan the QR code to access the manual in multiple languages.



Luminaires not suitable for covering with thermally insulating material.



Non-replaceable light source

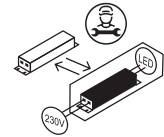

Replaceable control gear by a professional

INSTALLATION DIAGRAM

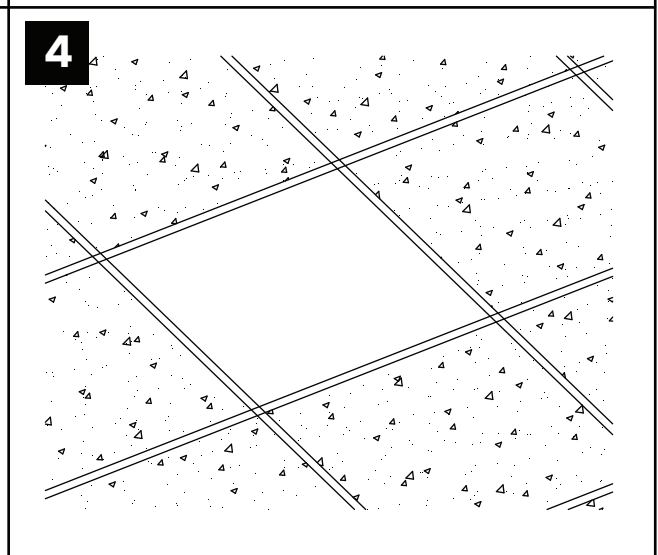
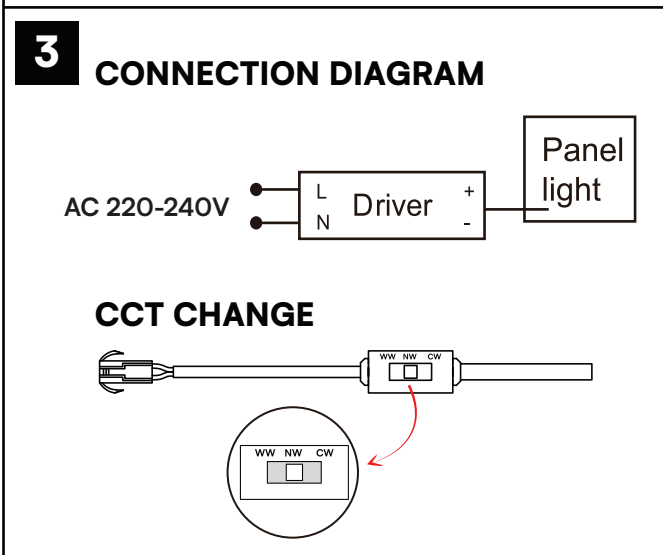
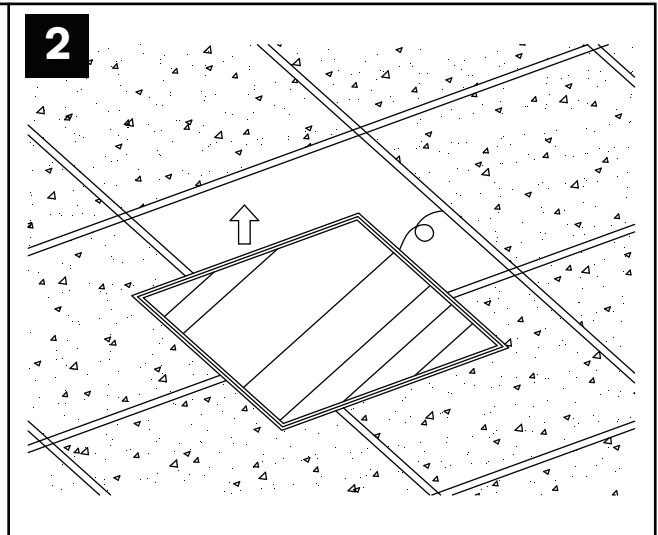
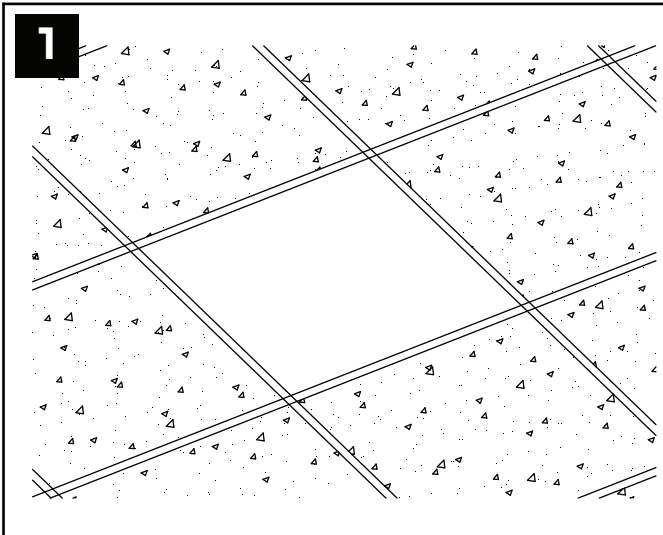

INSTALLATION INSTRUCTIONS

1. Ensure the power is turned off before starting the installation.
2. Cut an appropriately sized hole in the ceiling.
3. Mount the panel securely into the ceiling opening.
4. Connect the DC cable from the panel to the driver.
5. Connect the AC source cable to the input side of the driver.
6. Adjust the color temperature to the desired position using the CCT switch.
7. Turn on the power and test the lamp.

Note: The panel works on DC 30-40V, please connect correctly with the conductor before connecting the conductor to the power supply main.



V-TAC WEST EUROPE LTD. IN CASE OF ANY QUERY/ISSUE WITH THE PRODUCT, PLEASE REACH OUT TO US AT:
SUPPORT@V-TAC.EU FOR MORE PRODUCTS RANGE, INQUIRY PLEASE CONTACT OUR DISTRIBUTOR OR NEAREST DEALERS.
V-TAC WEST EUROPE LTD. GROUND FLOOR, 71 LOWER BAGGOT STREET, DUBLIN 02, IRELAND D02 P593

V-TAC UK LTD. IN CASE OF ANY QUERY/ISSUE WITH THE PRODUCT PLEASE REACH OUT TO US AT:
SUPPORT@VTACEXPORTS.COM V-TAC, 5A TUNGSTEN PARK, DOWNS ROAD, WITNEY, OXFORDSHIRE, OX29 0AX